

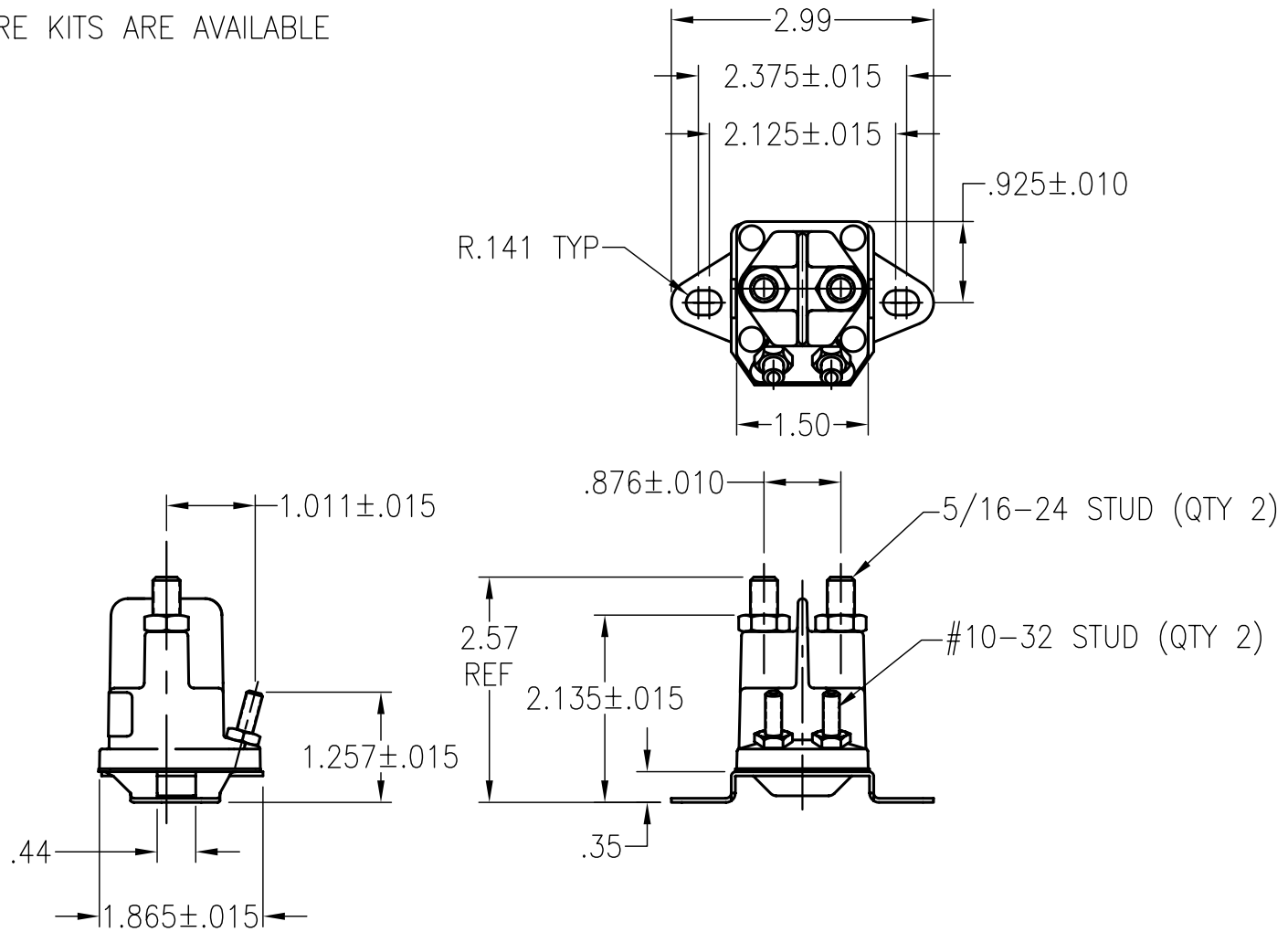

NOTE: BULK HARDWARE KITS ARE AVAILABLE



						MATERIAL	 MOTION TECHNOLOGIES				
						FINISH				884 CONTACTOR STD BRKT DIMENSIONAL ASSEMBLY	
						UNLESS OTHERWISE SPECIFIED					
A	RELEASE	JMG	4038	10/23/02	DAH	.XXX +/- .005	.XX +/- .01	ANG. +/- 1°	DRAWN JMG	SCALE 1:2	DWG. NO.
REV.	DESCRIPTION	BY	ECN	DATE	APP.	BREAK ALL EDGES .005-.015	125/	FINISH	APPR. DAH	DATE 10/23/02	E08322
						FILLETS .010-.020 RAD.					